

Thank you for choosing our Autonics product.

**Read and understand the instruction manual and manual thoroughly before using the product.**

**For your safety, read and follow the below safety considerations before using.**

**For your safety, read and follow the considerations written in the instruction manual, other manuals and Autonics website.**

Keep this instruction manual in a place where you can find easily.

The specifications, dimensions, etc are subject to change without notice for product improvement. Some models may be discontinued without notice.

Follow Autonics website for the latest information.

### Safety Considerations

- Observe all 'Safety Considerations' for safe and proper operation to avoid hazards.
- ⚠ symbol indicates caution due to special circumstances in which hazards may occur.

**⚠ Warning** Failure to follow instructions may result in serious injury or death

**01. Fail-safe device must be installed when using the unit with machinery that may cause serious injury or substantial economic loss.** (e.g. nuclear power control, medical equipment, ships, vehicles, railways, aircraft, combustion apparatus, safety equipment, crime/disaster prevention devices, etc.)  
Failure to follow this instruction may result in personal injury, economic loss or fire.

**02. Do not use the unit in the place where flammable/explosive/corrosive gas, high humidity, direct sunlight, radiant heat, vibration, impact or salinity may be present.**  
Failure to follow this instruction may result in explosion or fire.

**03. Do not disassemble or modify the unit.**  
Failure to follow this instruction may result in fire.

**04. Do not connect, repair, or inspect the unit while connected to a power source.**  
Failure to follow this instruction may result in fire.

**05. Check 'Connections' before wiring. [Amplifier unit]**  
Failure to follow this instruction may result in fire.

**⚠ Caution** Failure to follow instructions may result in injury or product damage

**01. Do not stare at the laser emitter. [Sensor head]**

Failure to follow this instruction may result in damage on eyes.

**02. Use the unit within the rated specifications.**

Failure to follow this instruction may result in fire or product damage.

**03. Use a dry cloth to clean the unit, and do not use water or organic solvent.**

Failure to follow this instruction may result in fire.

**04. Mount the ferrite core to specified position before using. [Sensor head, Extension cable]**

Failure to follow this instruction may result in output with noise.

### Cautions during Use

- Follow instructions in 'Cautions during Use'. Otherwise, it may cause unexpected accidents.
- The power supply should be insulated and limited voltage/current or Class 2, SELV power supply device.
- Do not install where strong magnetic or electric field exist. Otherwise, the resolution may be adversely affected.
- Mutual optical interference between laser sensors and photoelectric sensors may result in malfunction.
- Mutual optical interference between laser sensors may result in malfunction.
- When connecting DC relay or other inductive load to the output, remove surge by using diode or varistor.
- Wire as short as possible and keep away from high voltage lines or power lines, to prevent surge and inductive noise. [Amplifier unit]
- For the optimized performance, it is recommended to measure after 30 minute from supplying power. [Amplifier unit]
- Since external disturbance light (sunlight, fluorescent lighting, etc.) can cause product malfunction, use the product with a light shield or slit. [Sensor head]

- When detecting with the maximum sensitivity, an error may occur depending on each characteristic deviation.
- This unit may be used in the following environments.
  - Indoors (in the environment condition rated in 'Specifications')
  - Altitude max. 2,000 m
  - Pollution degree 2
  - Installation category II

### Manual

For the detail information and instructions, please refer to user manual, and be sure to follow cautions written in the technical descriptions (catalog, website).  
Visit our website (www.autonics.com) to download manuals.

### Ordering Information

This is only for reference.

For selecting the specified model, follow the Autonics website.

#### ■ Sensor head

Model	Reference distance (Maximum measurement range)
BD-030	30 mm (20 to 40 mm)
BD-065	65 mm (50 to 80 mm)
BD-100	100 mm (70 to 130 mm)

#### ■ Amplifier unit

Model	Compatible sensor head
BD-A1	BD Series sensor head: 1

### Sold Separately

- General type extension cable: CID6P-□-SI-BD
- Robot type extension cable: CIDR6P-□-SI-BD
- Laser displacement sensor communication converter: BD-C Series

### Dimensions

- Unit: mm, For the detailed drawings, follow the Autonics website.

#### ■ Sensor head

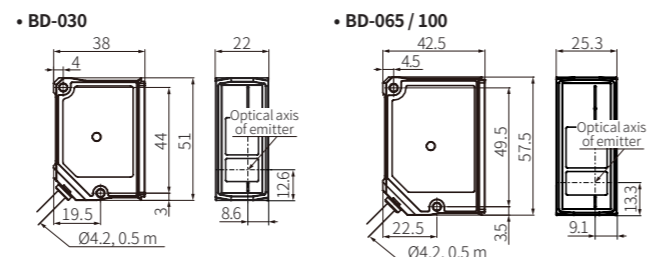

#### - Bracket

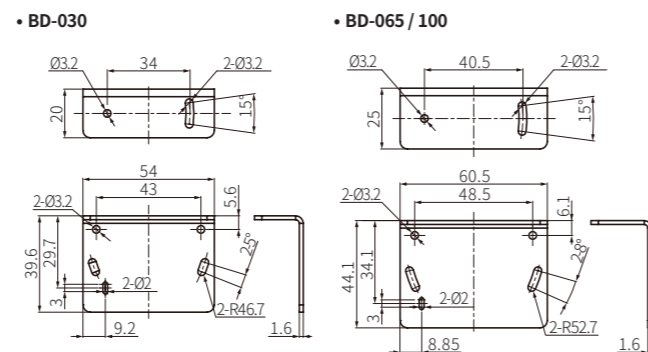

#### - Ferrite core

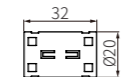

#### ■ Amplifier unit

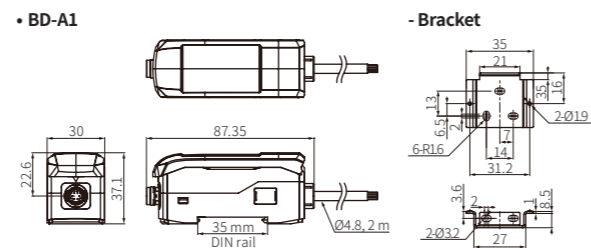

### Specifications

■ Sensor head			
Model	BD-030	BD-065	BD-100
Beam shape	Standard		
Spot diameter (near)	≈ 290×790 μm (25 mm)	≈ 360×1,590 μm (55 mm)	≈ 480×1,870 μm (80 mm)
Spot diameter (reference)	≈ 240×660 μm (30 mm)	≈ 290×1,180 μm (65 mm)	≈ 410×1,330 μm (100 mm)
Spot diameter (far)	≈ 190×450 μm (35 mm)	≈ 210×830 μm (75 mm)	≈ 330×950 μm (120 mm)
Resolution <sup>(01)</sup>	1 μm	2 μm	4 μm
Reference distance	30 mm	65 mm	100 mm
Maximum measurement range	20 to 40 mm	50 to 80 mm	70 to 130 mm
Rated measurement ranges <sup>(02)</sup>	25 to 35 mm	55 to 75 mm	80 to 120 mm
Linearity <sup>(01)(03)</sup>	± 0.1% of F.S.	± 0.1% of F.S.	± 0.15% of F.S.
Temperature characteristic <sup>(04)</sup>	0.05% F.S./°C	0.06% F.S./°C	
Power supply <sup>(05)</sup>	-		
Light source	Red semiconductor laser (wavelength: 660 nm, IEC 60825-1:2014)		
Optical method	Diffuse reflection		
Laser class	Class 1 (IEC/EN), Class I (FDA (CDRH) CFR Part 1002)	Class 2 (IEC/EN), Class II (FDA (CDRH) CFR Part 1002)	
Output	≤ 300 μW	≤ 1 mW	
Operation Indicator	Power Indicator (red), Laser emission indicator (green), NEAR/FAR indicator (green)		
Connection	Connector type		
Insulation resistance	≥ 20 MΩ (500 VDC≐ megger)		
Noise immunity	Square shaped noise by noise simulator (pulse width: 1μs) ±500V		
Dielectric strength	1,000 VAC~ 50/60 Hz for 1 minute		
Vibration	1.5 mm amplitude at frequency of 10 to 55Hz (for 1 min) in each X, Y, Z direction for 2 hours		
Shock	300 m/s <sup>2</sup> (≈ 30 G) in each X, Y, Z direction for 3 times		
Ambient illumination	≤ 10,000 lx Incandescent lamp		
Ambient temperature	-10 to 50 °C, Storage: -15 to 60 °C (no freezing or condensation)		
Ambient humidity	≤ 85%RH, Storage: ≤ 85%RH (no freezing or condensation)		
Protection structure	IP67 (IEC Standards, except connector of extension cable)		
Material	Case: Polycarbonate, Sensing part: Glass, Cable: Polyvinyl chloride		
Amplifier unit compatibility	BD Series amplifier unit: 1		
Accessory	Ferrite core (made by TDK co. ZCAT2132-1130), Mounting bracket, Bolt, Nut		
Approval	CE, RoHS, ENEC		
Unit weight (packaged)	≈ 56 g (≈ 209 g)	≈ 68 g (≈ 233 g)	≈ 68 g (≈ 233 g)

(01) When measuring fixed non-glossy white paper (reference temperature: 25°C, reference distance, response time: 1ms, average 128 times).

(02) The rated measurement range guarantees linearity.

(03) Value indicates the error with respect to the ideal straight line.

(04) Value measured by using an aluminum jig fix the sensor head and non-glossy white paper.

(05) Using power from the amplifier unit.

#### ■ Amplifier unit

Model	BD-A1
Power supply	10 - 30 VDC≐ ±10% (when connecting BD-C Series communication converter, 12-30 VDC≐)
Power consumption <sup>(1)</sup>	≤ 2,800 mW (30 VDC≐)
Control Input <sup>(2)</sup>	Timing / Output reset / Laser OFF / Zero-point adjustment / Bank change: No-voltage input
Judgment output (HIGH/GO/LOW)	NPN or PNP open collector output (load current: ≤ 100 mA)
Alarm output	NPN or PNP open collector output (load current: ≤ 100 mA)
Analog voltage output <sup>(3)</sup>	-5 - 5V, 0 - 5V, 1 - 5V (resistance: 100 Ω, ± 0.05% F.S., at 10V)
Analog current output <sup>(3)</sup>	4 - 20 mA (load resistance: ≤ 350 Ω, ± 0.2% F.S., at 16 mA)
Residual voltage	NPN: ≤ 1.5V, PNP: ≤ 2.5V
Protection circuit	Reverse polarity protection circuit, output over current (short-circuit) protection circuit
Response Time	0.33 / 0.5 / 1 / 2 / 5 ms
Min. display unit	1 μm
Display type	11 segment (red, green), 6-digit, LED
Display range <sup>(4)</sup>	±99,999 mm to ±99 mm (4-step adjustment, parameter)
Display period	≈ 100 ms
Insulation resistance	≥ 20 MΩ (500 VDC≐ megger)
Noise immunity	Square shaped noise by noise simulator (pulse width: 1 μs) ±500 V
Dielectric strength	1,000 VAC~ 50/60 Hz for 1 minute
Vibration	1.5 mm amplitude at frequency of 10 to 55 Hz (for 1 min) in each X, Y, Z direction for 2 hours
Shock	300 m/s <sup>2</sup> (approx. 30 G) in each X, Y, Z direction for 3 times
Ambient temperature	-10 to 50 °C, Storage: -15 to 60 °C (no freezing or condensation)
Ambient humidity	≤ 85%RH, Storage: ≤ 85%RH (no freezing or condensation)
Material	Case: PC, Cover: PC, cable: PVC
Connection	Connector type
Sensor head compatibility	BD series sensor head: 1
Accessory	Mounting bracket, Side connector
Protection structure	IP40 (IEC standard)
Approval	CE, RoHS, ENEC
Unit weight (packaged)	≈ 126 g (≈ 228 g)

(01) Power to the load is not included.

(02) Use after assigning to external input line.

(03) It is possible to use among -5V, 0-5V, 1-5V, 4-20mA by parameter setting.

(04) Setting range is assigned automatically when connecting sensor head.

### Unit Descriptions

#### ■ Sensor head

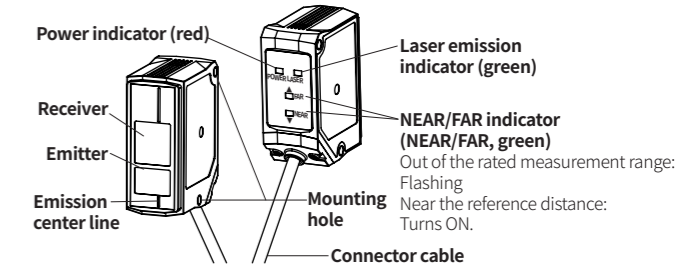

- Emission center line and the object should be aligned because the laser is emitted along the line.
- For the details about indicators, refer to 'Indicator display'.

#### ■ Amplifier unit

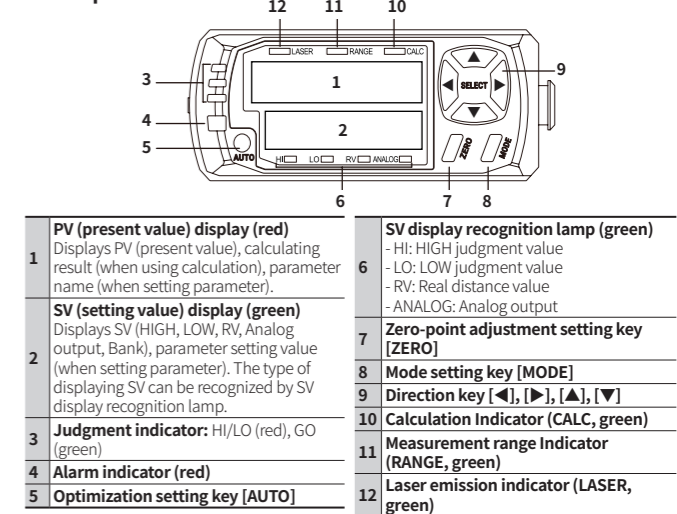

### [Amplifier unit] Connection

Color	Description	Item
Brown	Power: 10 - 30 VDC≐	Power
Blue	Common GND (Input/Output/Power)	
Black	HIGH judgment output	Output
Orange	LOW judgment output	
Gray	GO judgment Output	
Green	Alarm output	
White	Analog output	External input
Shield	Analog output GND <sup>(01)</sup>	
Pink	External input1	
Yellow	External input2	
Red	External input3	Timing, Output reset, Laser OFF, Zero-point adjustment, Bank A, Bank B, OFF
Purple	External input4	

(01) It is needed to distinguish from common GND.

### Control Output Diagram

#### ■ Judgment (High, Go, Low) and alarm output

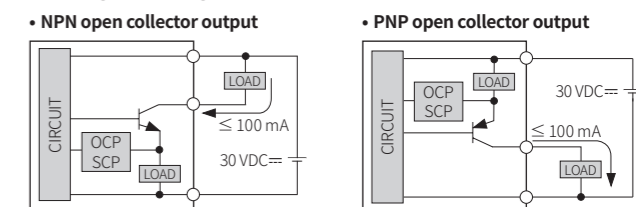

#### ■ Analog output

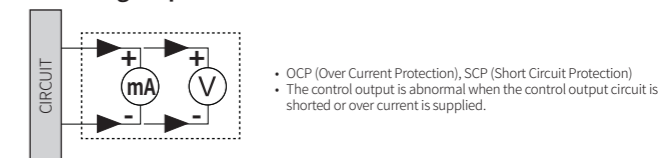

- OCP (Over Current Protection), SCP (Short Circuit Protection)
- The control output is abnormal when the control output circuit is shorted or over current is supplied.

Installation Procedures		
No.	Chapter	Description
1	Check reference distance and select mounting location.	As the distance between the sensor head and the object approaches the reference distance, accurate measurements can be made. Refer to 'Mounting Location' to select optimum mounting location.
2	Check the precautions about the measurement.	In case of measuring moving or rotating object, it is needed to install the sensor head to correct direction. When measuring at narrow area or concave object, it is needed to set the position of the sensor head. For the details, refer to 'Installation Precautions'.
3	Check mounting method and mount.	Mount to the panel directly or through the enclosed bracket. Refer to 'Mounting and Connecting Method' to mount the sensor head.
4	Check and apply the function of amplifier unit.	BD series support various settings and functions such as pitch light optimization, zero adjustment setting, automatic sensitivity setting, calculation through the amplifier unit.

### [Sensor head] Mounting Location

Select mounting location regarding displacement of the object, reference distance and measurement range. Mount sensor head where the object is located at the reference distance by checking the operation of indicators and displacement value.

#### Indicator display

Check the operation of indicators to know distance between sensor head and the object.

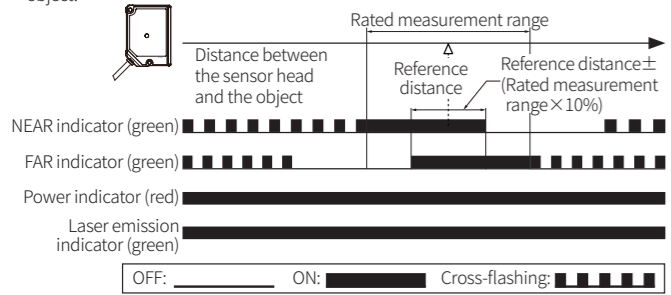

#### Displacement indication

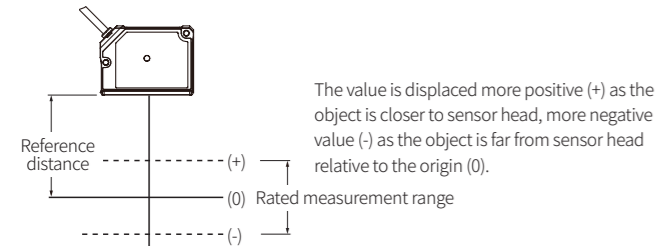

#### Indication by distance

• Unit: mm

Model	Reference distance	Rated measurement range	Indication		
			NEAR ON	NEAR / FAR ON	FAR ON
BD-030	30	25 to 35	25 to 31	29 to 31	29 to 35
BD-065	65	55 to 75	55 to 67	63 to 67	63 to 75
BD-100	100	80 to 120	80 to 104	96 to 104	96 to 120

### [Sensor head] Installation Precautions

For stable measurement, mount the sensor head by referring to the below items.

#### Moving object measurement

**Object with material / color difference**

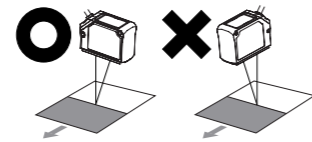

**Rotating object**

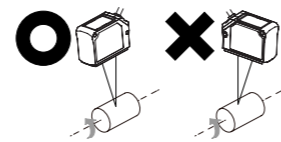

Install the emitter and receiver in parallel to the material or color boundary of the object.

Install the receiver and the rotating shaft in parallel to minimize the influence of fluctuations and position deviations.

#### Object with step

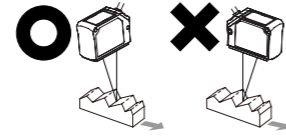

Install the emitter and receiver vertically to the line between crest and valley of the object.

#### Narrow area or concave object

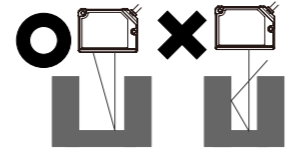

Install the sensor head where the reflected laser beam does not blocked toward the receiver part.

#### Wall mounting

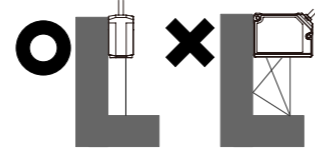

Install the sensor head where the reflected laser beam from the wall does not enter the receiver part. If the color of wall is black with low reflectivity and no gloss, the error can be minimized.

#### Black object

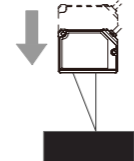

When measuring black object with low reflectance the amount of light received decreases, install the sensor head closely to the object.

### Installation

#### Sensor head

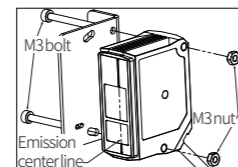

- Mount to the panel directly or through the bracket by using M3 bolt and nut (tightening torque:  $\leq 0.5 \text{ N} \cdot \text{m}$ ).
- Check the mounting position considering emission center line, vibration and shock.

#### Amplifier unit

##### - Mounting with bolt

- Mounting without DIN rail is possible by using bracket.
- The method of mounting and detaching with bracket is as same as DIN rail.

##### - DIN rail installation

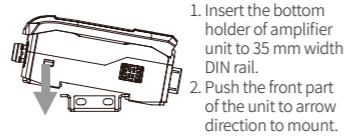

##### - Removing from DIN rail

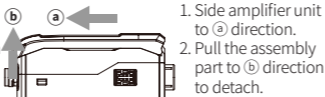

#### Ferrite core (accessory)

Sensor head	Extension cable (sold separately)
Within 30 mm from the sensor head, wind the cable through the inside of the ferrite core three times and mount the ferrite core.	Within 30 mm from the connector of amplifier unit, wind the cable through the inside of the ferrite core three times and mount the ferrite core.

#### Connecting to amplifier unit

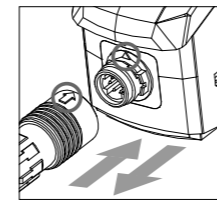

- Connecting: Insert connector of the sensor head into amplifier unit with aligning  $\uparrow$  mark and  $\blacktriangle$  mark until it sounds click.
- Disconnecting: Pull out the connector cap of sensor head to the opposite direction.

#### Connecting amplifier units mutually

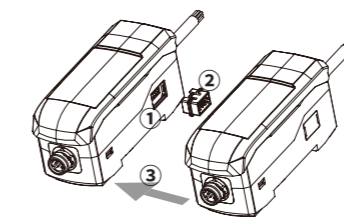

- Remove the side cover at the connecting side.
- Connect the side connector to the units.
- After mounting amplifier unit on DIN rail, push it to arrow direction tightly.
  - In case of disconnecting, follow the upper sequence reversely.

#### Distinguishing master/slave amplifier units

When the power cable direction is down, the amplifier at the left end is the master unit, and the channel number of slaves increases sequentially to the right.

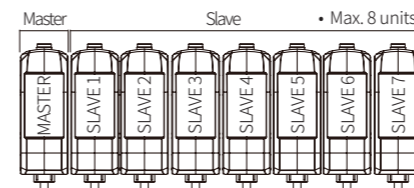

#### Precautions when connecting amplifier unit

- Mount on DIN rail.
- Do not supply the power when adding amplifier unit.
- Supply power to each connected amplifier unit at the same time.
- Up to 8 amplifier units can be connected, and only 1 calculation function can be performed per 1 group of mutually connected amplifiers.
- When the calculation function is activated, the SV of the slave units are disable and the mutual interference prevention function for sensor heads is executed automatically.

### [Amplifier unit] Display When Power is ON

Displays control output setting screen when connecting a sensor head and supplying power at the first time, or replacing a sensor head. Set the output type as below sequence.

Refer to 'Mode setting' to check the setting range and the reset method.

	1. Control output type	2. Analog output type	3. Entering RUN mode
PV display	$\alpha U t$	$R - \alpha U t$	$\alpha U t . S E t$
Description	When 'OUT' is displayed on the PV display, select control output type through the $\blacktriangle$ , $\blacktriangledown$ keys and push the [MODE] key.	When 'A-OUT' is displayed on the PV display, select analog output type through the $\blacktriangle$ , $\blacktriangledown$ keys and push the [MODE] key.	After 'OUT.SET' is flashed three times and it returns to the run mode.

### [Amplifier unit] Mode Setting

[AUTO] key over 2 sec	<b>Sensing optimization</b>	Auto	
[ZERO] key over 2 sec	<b>Zero-point adjustment</b>	Start: [ZERO] key within 1 sec Stop: [ZERO]+[MODE] key over 2 sec	
[MODE]+ $\blacktriangle$ key over 2 sec	<b>HIGH sensitivity adjustment</b>	Set digit: $\blacktriangle$ , $\blacktriangledown$ key Set value: $\blacktriangledown$ , $\blacktriangle$ key	
[MODE]+ $\blacktriangledown$ key over 2 sec	<b>LOW sensitivity adjustment</b>	Save: [MODE] key within 2 sec	
[MODE] key within 2 sec	<b>Auto sensitivity (Teaching)</b>	Auto	
[MODE]+[AUTO] key over 2 sec	<b>Control output type</b>	Set value: $\blacktriangledown$ , $\blacktriangle$ key Save: [MODE] key Auto after flashing OUT.SET in PV display and END in SV display part 3 times	
$\blacktriangle$ key	<b>HIGH PEAK value</b>	$\blacktriangle$ , $\blacktriangledown$ , $\blacktriangledown$ , $\blacktriangle$ key or auto after no key input for 5 sec	
$\blacktriangledown$ key	<b>LOW PEAK value</b>		
[MODE] key over 2 sec	<b>Parameter group</b>	[MODE] key over 3 sec	

### [Amplifier unit] Parameter Setting

- Some parameter are activated / deactivated depending on other parameters. Refer to the description.
- [MODE] key: Enters parameter group, save and return to the upper step (over 3 sec)
- $\blacktriangle$ ,  $\blacktriangledown$  key: Changes parameter group, parameter
- $\blacktriangle$ ,  $\blacktriangledown$  key: Changes setting value of parameter
- Refer to the user manual for the details.

#### Parameter group 1

Parameter	Display	Default
Response time	$R S P d$	$I H S$
Teaching mode	$S E N S$	$I P N t$
Output type	$N \alpha N t$	$N \alpha$
PV display	$d i S P$	$S t N d$
Display digit	$d o t$	$0 0 0 0$
Display scale low limit	$H - S t$	Different by model
Display scale high limit	$L - S t$	Different by model
Hysteresis	$H Y S$	$0 0 0 1$
Analog output scale low limit	$H - A N$	Different by model
Analog output scale high limit	$L - A N$	Different by model
Error output	$E R R \alpha U t$	$K E E P$
Fixed output	$F i x \alpha U t$	Max. value

#### Parameter group 2

Parameter	Display	Default
Calculation	$C A L t$	$\alpha F F$
Gain	$G A I N$	$1$
Filter	$F I L t E R$	$A V F$
Samples for averaging	$A V F$	$1 6$
Samples for median	$M E d i A N$	$\alpha F F$
Hold	$H o L d$	$\alpha F F$
Hold timing input	$H o L d t$	$t - 1 N$
Auto trigger level	$A t t r$	$0$
Auto trigger Hysteresis	$A t t r H Y S$	$0 0 0 1$
Timer	$t - M o d$	$\alpha F F$
Timer value	$t i M E$	$0$

#### Parameter group 3

Parameter	Display	Default
External input 1	$d - 1 N 1$	$t - 1 N$
External input 2	$d - 1 N 2$	$\alpha U t . C L R$
External input 3	$d - 1 N 3$	$L - \alpha F F$
External input 4	$d - 1 N 4$	$Z E R \alpha$

#### Parameter group 4

Parameter	Display	Default
Display direction	$d i R$	Normal display
Bank	$b A N K$	$b A N K - 0$
Saving mode	$S A V E$	$\alpha F F$
Lock mode	$L o c k$	$\alpha F F$
Initialize	$i N i t$	$\alpha F F$

### Mode: Auto Sensitivity (Teaching)

Set the judgment output (HIGH/GO/LOW) range automatically. Enter the auto sensitivity adjustment setting mode after set the type of teaching mode in parameter group 1.

#### 1-point teaching

Sets the judgment output range by using present value (PV) of reference object height. HIGH setting value=height present value $\times 1.5$   
LOW setting value=height present value $\div 2$

#### Setting

- '1P' is displayed on SV display, push the [AUTO] key within 2 sec.
- After teaching the object for 2 sec, set the judgment output range automatically by applying the result.

#### 2-point teaching

Sets the judgment output range by using present value (PV) of reference object step. HIGH setting value=(step $\times 1.5$ )+bottom height  
LOW setting value=(step $\div 2$ )+bottom height

#### Setting

- '1P' is displayed on SV display, push the [AUTO] key within 2 sec.
- After teaching the object for 2 sec, '2P' is displayed on SV display, push the [AUTO] key within 2 sec.
- After teaching the object for 2 sec, set the judgment output range automatically by applying the result.

### Mode: Control Output Type

Sets the type of control/analog output.

#### Setting range

Output type	Setting range
Control output	NPN, PNP
Analog output	OFF, 4-20MA, 0-5V, 1-5V, -5~-5 to 5 V